

Perfiles de aluminio de superficie y de empotrar

SUPERFICIE	Ref.	Descripción	P.V.P
	PF005	Perfil superficie	5,95€/m
	PF006	Difusor translúcido	4,80€/m
	PF007	Difusor transparente	4,80€/m
	PF008	Tapa final con agujero	2,50€
	PF009	Tapa final sin agujero	2,50€
	PF023	Soporte perfil	1,50€
	PF024	Soporte basculante	3,00€

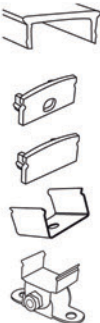
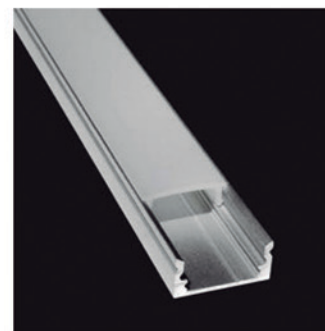
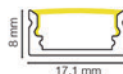
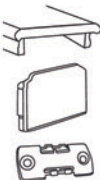

* Perfil no compatible con cable IP 65/66

SUPERFICIE	Ref.	Descripción	P.V.P
	PF015	Perfil superficie	6,75€/m
	PF011	Difusor translúcido	4,80€/m
	PF012	Difusor transparente	4,80€/m
	PF013	Tapa final	2,50€
	PF014	Soporte perfil	1,00€

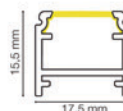

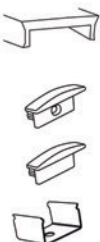
EMPOTRAR	Ref.	Descripción	P.V.P
	PF020	Perfil empotrar	7,00€/m
	PF004	Difusor translúcido	4,80€/m
	PF044	Difusor transparente	8,70€/m
	PF021	Tapa final con agujero	2,50€
	PF022	Tapa final sin agujero	2,50€
	PF023	Soporte perfil	1,50€

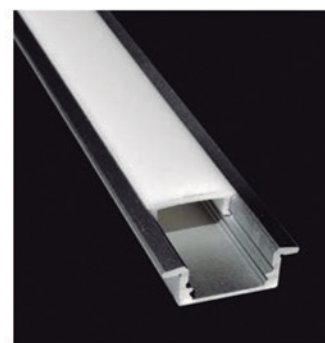
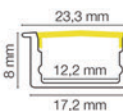





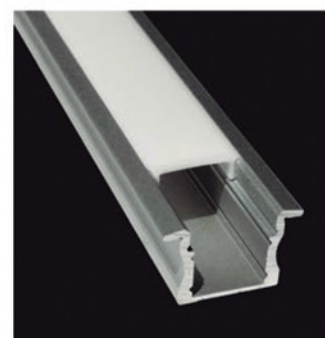
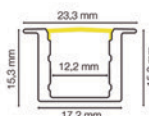

* Perfil no compatible con cable IP 65/66

EMPOTRAR	Ref.	Descripción	P.V.P
	PF030	Perfil empotrar	9,50€/m
	PF006	Difusor translúcido Difusor	4,80€/m
	PF007	transparente	4,80€/m
	PF032	Tapa final con agujero	2,50€
	PF031	Tapa final sin agujero	2,50€
	PF023	Soporte perfil	1,50€



Perfil de aluminio esquinero de superficie

ESQUINERO	Ref.	Descripción	P.V.P
	PF040	Perfil esquinero	8,86€/m
	PF004	Difusor translúcido	4,00€/m
	PF044	Difusor transparente	4,00€/m
	PF041	Tapa con agujero	1,01€
	PF042	Tapa sin agujero	1,01€
	PF043	Soporte perfil	1,14€

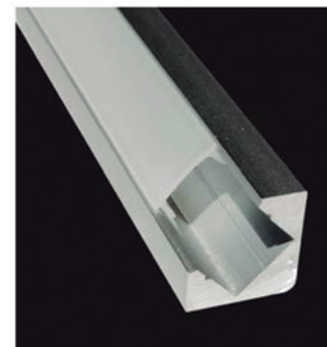
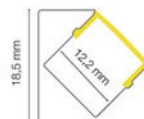

Sobrecostes de manipulación

Ref.	Descripción	P.V.P
LED CORTE IP	Corte cinta IP65/66	3,50€
LED CORTE P	Corte perfil para cinta	1,01€
LED MON	Corte + montaje cinta en perfil	3,25€
LEDCABLE	Metro cable rojo/negro para cinta	0,50€

STOCK EN TALLER

Cintas flexibles de alta reproducción cromática - potencia 9,6W

IP20 SLP

Tira de LED flexible de 9,6W/m y 140 LED/m. Adhesivo 3M en la parte posterior para su fácil instalación en perfil de aluminio.

TIRA	POTENCIA	COLOR	IP	LUMEN/M	CRI		P.V.P
SLP 4020	9,6 W	4000 K	20	1.150 lm/m	90	24VDC	10,68€/m
SLP 3020	9,6 W	3000 K	20	1.115 lm/m	90	24VDC	10,68€/m
SLP 2720	9,6 W	2700 K	20	1.080 lm/m	90	24VDC	10,68€/m

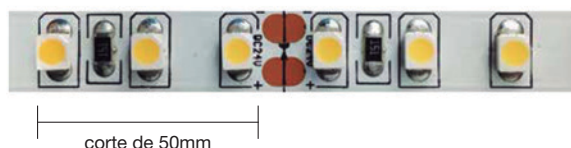

IP62 SLP

Tira de LED flexible de 9,6W/m y 140 LED/m. Adhesivo 3M en la parte posterior para su fácil instalación en perfil de aluminio.

TIRA	POTENCIA	COLOR	IP	LUMEN/M	CRI		P.V.P
SLP 4062	9,6 W	4000 K	62	1.140 lm/m	90	24VDC	13,30€/m
SLP 3062	9,6 W	3000 K	62	1.060 lm/m	90	24VDC	13,30€/m
SLP 2762	9,6 W	2700 K	62	1.030 lm/m	90	24VDC	13,30€/m



Cintas flexibles de alta reproducción cromática - potencia 14,4W

IP20 SLS

Tira de LED flexible de 14,4W/m y 210 LED/m. Adhesivo 3M en la parte posterior para su fácil instalación en perfil de aluminio.

TIRA	POTENCIA	COLOR	IP	LUMEN/M	CRI		P.V.P
SLS 4020	14,4 W	4000 K	20	1.740 lm/m	90	24VDC	13,50€/m
SLS 3020	14,4 W	3000 K	20	1.680 lm/m	90	24VDC	13,50€/m
SLS 2720	14,4 W	2700 K	20	1.630 lm/m	90	24VDC	13,50€/m

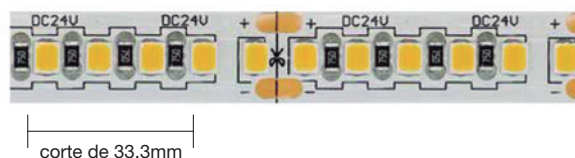

IP62 SLS

Tira de LED flexible de 14,4W/m y 210 LED/m. Adhesivo 3M en la parte posterior para su fácil instalación en perfil de aluminio.

TIRA	POTENCIA	COLOR	IP	LUMEN/M	CRI		P.V.P
SLS 4062	14,4 W	4000 K	62	1.480 lm/m	90	24VDC	15,34€/m
SLS 3062	14,4 W	3000 K	62	1.400 lm/m	90	24VDC	15,34€/m
SLS 2762	14,4 W	2700 K	62	1.250 lm/m	90	24VDC	15,34€/m

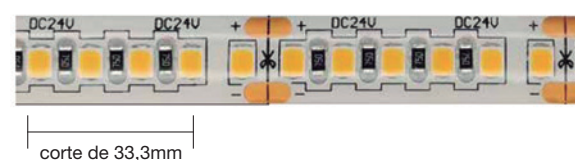

Cinta LED 220V/AC

Cinta LED flexible IP67

220V/AC - Bobina 50m - SMD 2835

Ref.	Descripción	Consumo	P.V.P
TFX2300-220V-10	2.300K - 1.550 Lm/m - IP67	17W/m	17,80€/m
TFXBSC-220V-10	2.700K - 1.550 Lm/m - IP67	17W/m	17,80€/m
TFXBC-220V-10	3.000K - 1.580 Lm/m - IP67	17W/m	17,80€/m
TFXBD-220V-10	4.000K - 1.635 Lm/m - IP67	17W/m	17,80€/m
TFXBF-220V-10	6.000K - 1.700 Lm/m - IP67	17W/m	17,80€/m
CE-TFX220V	Tapón inicial para tira 220Vac		1,17€
CF-TFX220V	Tapón final para tira 220Vac		0,97€
CT-TFX220V	Conector inicial con tornillo para tira 220Vac		4,90€

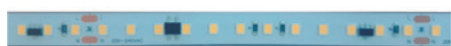

CE-TFX220V



CF-TFX220V



CT-TFX220V

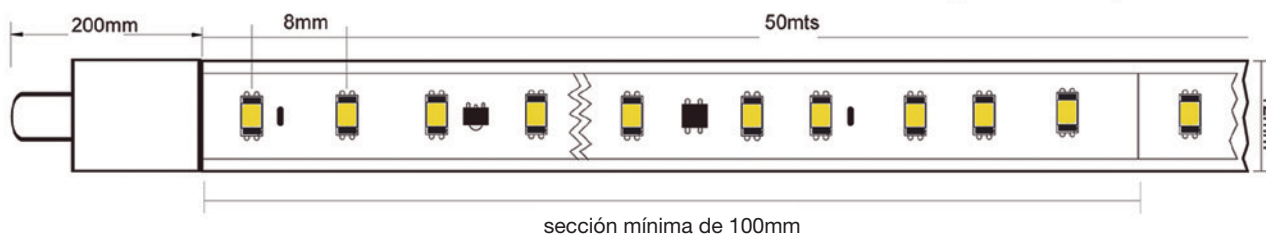
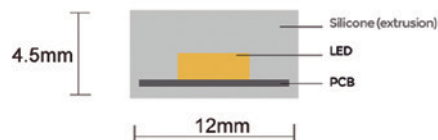
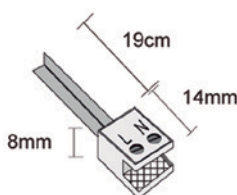

Regulador recomendado de VARILAMP Ref. MULTI DIMMER 250:



Perfil para cinta LED a 220V/AC + RGB 230V/AC

Medidas: 2.000 x 12,1 x 19,6 mm

Ref.	Descripción	P.V.P
PA-CO/2	Perfil aluminio tipo 16mm	7,50€/m
DF-O/2CO-P	Difusor opal mate plano para perfil CO/2	4,65€
TFS-CO/2P	Tapón final ciego para CO/2 plano	0,96€
TFC-CO/2P	Tapón final con agujero para CO/2 plano	0,96€
GR-P72CO	Grapa perfil CO/2	0,96€

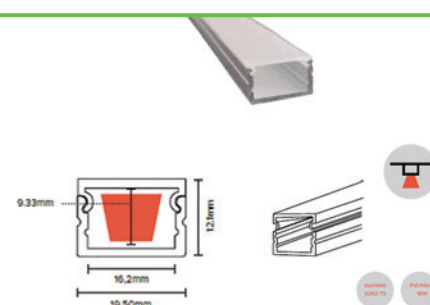

STOCK EN TALLER

Cinta LED RGB 230V/AC

Cinta LED RGB flexible IP67

230V/AC - Ángulo 110° - Bobina 50m

Ref.	Descripción	Consumo	P.V.P
TFXRGB-220V-10	RGB - 250 Lm/m - 72 leds/m - IP67	12W/m	23,65€/m
CE-TFX220V	Tapón inicial para tira 220Vac		1,17€
CF-TFX220V	Tapón final para tira 220Vac		0,97€
CO-TFXRGB220V	Controlador RGB para tira 220Vac		78,00€

Necesita disipador / Tramo máximo 50m (1 bobina) - Vida útil de 50.000 horas

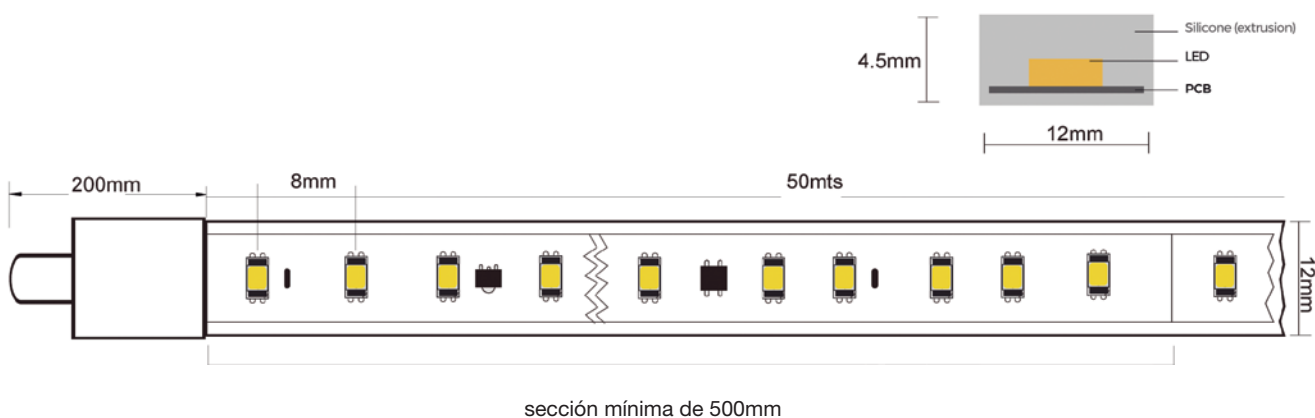

Corte y manipulación cintas LED

Ref.	Descripción	P.V.P
LED CORTE	Corte cinta IP20	2,25€
LED CORTE IP	Corte cinta IP65/66	3,50€
LED CORTE P	Corte perfil y difusor	1,00€
LED MON	Corte + montaje cinta perfil	3,25€
LEDCABLE	Metro cable rojo/negro para cinta	0,50€/m
LED CORTE RGB	Corte cinta RGB	4,50€

Cintas LED 12VDC - Gama ECO

Manipulados solicitar información.





Cintas LED flexibles IP20

12 VDC - 14,5W/m - Bobina 5m - 60 leds/m - 5cm corte

Ref.	Descripción	P.V.P
LM2014	SMD 5050-60 - 3.000K - 800 Lm/m 	13,86€/m
LM2016	SMD 5050-60 - 4.000K - 800 Lm/m 	15,87€/m
LM2010	SMD 5050-60 - 6.000K - 800 Lm/m 	15,90€/m
LM2011	Led 5050-60 - Azul 	15,90€/m
LM2012	Led 5050-60 - Rojo 	13,86€/m
LM2013	Led 5050-60 - Verde 	13,86€/m
LM2015	Led 5050-60 - RGB 	17,52€/m

Cintas LED flexibles IP65

12 VDC - 14,5W/m - Bobina 5m



Ref.	Descripción	P.V.P
LM2005	SMD 5050-60 - 3.000K - 800 Lm/m 	22,11€/m
LM2001	SMD 5050-60 - 6.000K - 800 Lm/m 	22,11€/m
LM2002	SMD 5050-60 - Azul 	17,70€/m
LM2004	SMD 5050-60 - Verde 	17,31€/m
LM2006	SMD 5050-60 - RGB 	23,70€/m

Cintas LED 24VDC - Gama ECO



Manipulados solicitar información.

Cintas LED flexibles IP20



24 VDC - 9W/m - Bobina 5m - 900 Lm/m - 120 leds/m - - 5cm corte

Ref.	Descripción	P.V.P
LM2216	SMD 2835 - 3.000K 	15,55€/m
LM2215	SMD 2835 - 4.500K 	15,55€/m
LM2214	SMD 2835 - 6.000K 	15,55€/m

24 VDC - 14,4W/m - Bobina 5m - 1.150 Lm/m - 60 leds/m - 10cm corte

Ref.	Descripción	P.V.P
LM2133	SMD 5050 - 3.000K 	14,95€/m
LM2132	SMD 5050 - 4.500K 	14,95€/m
LM2131	SMD 5050 - 6.000K 	14,95€/m

24 VDC - 18,5W/m - Bobina 5m - 1.800 Lm/m - 204 leds/m - 3cm corte

Ref.	Descripción	P.V.P
LM2067	SMD 2835 - 3.000K 	31,07€/m
LM2066	SMD 2835 - 4.000K 	31,07€/m
LM2065	SMD 2835 - 6.000K 	31,07€/m

Lámparas LED RGB + Blanco dinámico

Lámparas Mi-Light LED

Ref.	Descripción
FUT012	STD 9W/230V E2 - RGB + blanco dinámico 850 Lm - AC 100-240VC - 270°
FUT103	P16 GU10 4W - RGB + blanco dinámico 280 Lm RGB - AC 100-240VC - 25°

P.V.P

33,50€

24,00€



FUT012



FUT103

Mandos a distancia para lámparas RGB

Control distancia 30m R.F. 2,4 GHz

Ref.	Descripción
Mi4RGB	Mando distancia 4 zonas RGB + WHITE
MiB3	Panel táctil 12-36V 3x5A - 4 zonas RGB+W
MiT3	Panel táctil de empotrar C.UNV. 230V 4 zonas RGB+WHITE

P.V.P

14,50€

31,50€

28,60€



MiB3



Mi4RGB

Controlador cinta RGB + WHITE 12/24 VDC

Ref.	Descripción
FUT037	Receptor radiofrecuencia RGB Mi-Light 12-24VDC salida 6A por canal - total salida 10A

P.V.P

19,00€



FUT037



Sly IP20

ALEALED



Dimensiones en mm - Dimensions in mm

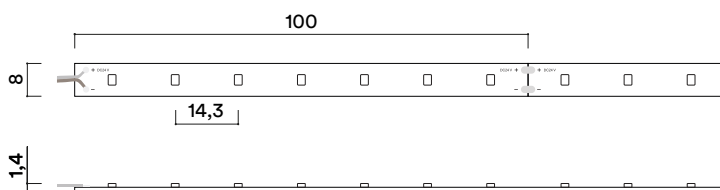

Descripción - Description

Tira de LED flexible de 4,8W/m y 70 LED/m. Adhesivo 3M en la parte posterior para su fácil instalación en perfil de aluminio.

Flexible LED strip with 4,8W/m and 70 LED/m. 3M high grip tape in the back side for easy installation in aluminium profile.

Perfil recomendado - Recommended profile

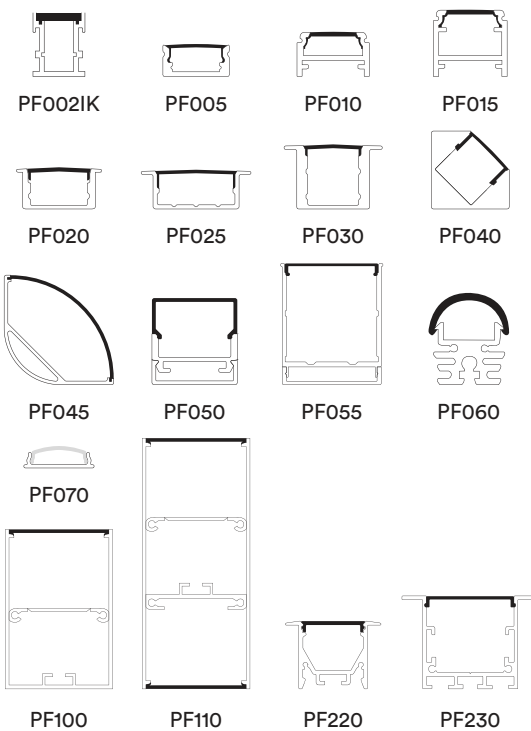

Información técnica - Technical information

*Consultar disponibilidad - Consult availability

Icono	Wattaje	Ángulo	Temperatura	Luminosidad	CRI	Regulación	Voltaje	Precio
⊕	4,8W	120°	5000K	580lm/m	90	L70 > 50.000H	24VDC	11,80€
⚡	4,8W	120°	4000K	570lm/m	90	L70 > 50.000H	24VDC	11,80€
∠	4,8W	120°	3000K	555lm/m	90	L70 > 50.000H	24VDC	11,80€
🌡️	4,8W	120°	2700K	530lm/m	90	L70 > 50.000H	24VDC	11,80€
☀️	4,8W	120°	2400K	460lm/m	90	L70 > 50.000H	24VDC	11,80€
🌞	4,8W	120°	2200K	420lm/m	90	L70 > 50.000H	24VDC	11,80€

Información adicional - Additional information

Regulación - Dimming



Sly IP62



Descripción - Description

Tira de LED flexible de 4,8W/m y 70 LED/m. Adhesivo 3M en la parte posterior para su fácil instalación en perfil de aluminio.

Flexible LED strip with 4,8W/m and 70 LED/m. 3M high grip tape in the back side for easy installation in aluminium profile.

Perfil recomendado - Recommended profile

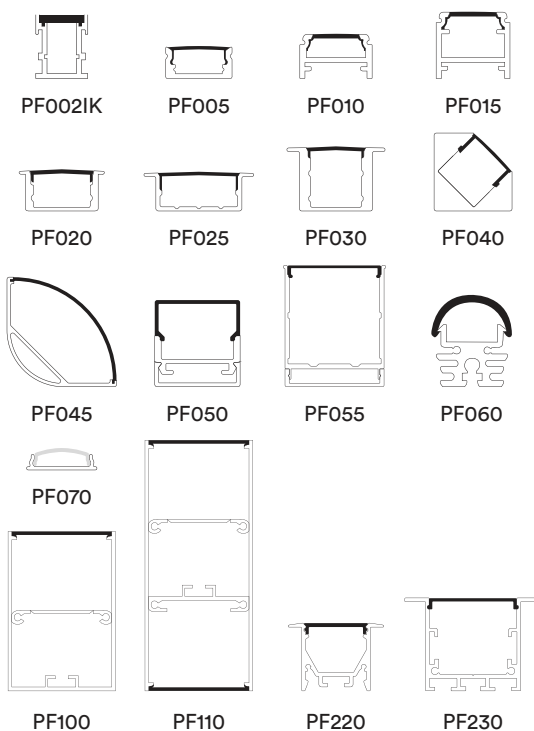

Dimensiones en mm - Dimensions in mm

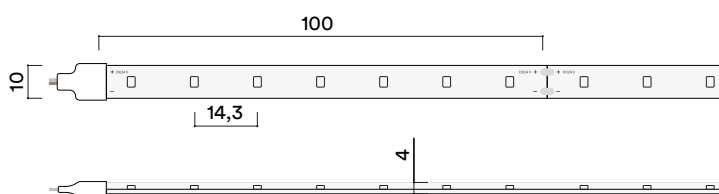

Información técnica - Technical information

*Consultar disponibilidad - Consult availability

					CRI			
SLY5062*	4,8W	120°	5000K	565lm/m	90	L70>50.000H	24VDC	14,20€
SLY4062	4,8W	120°	4000K	555lm/m	90	L70>50.000H	24VDC	14,20€
SLY3062	4,8W	120°	3000K	530lm/m	90	L70>50.000H	24VDC	14,20€
SLY2762	4,8W	120°	2700K	510lm/m	90	L70>50.000H	24VDC	14,20€
SLY2462*	4,8W	120°	2400K	440lm/m	90	L70>50.000H	24VDC	14,20€
SLY2262*	4,8W	120°	2200K	400lm/m	90	L70>50.000H	24VDC	14,20€

Información adicional - Additional information

Regulación - Dimming



Sly IP68

ALEALed



Descripción - Description

Tira de LED flexible de 4,8W/m y 70 LED/m. Adhesivo 3M en la parte posterior para su fácil instalación en perfil de aluminio.

Flexible LED strip with 4,8W/m and 70 LED/m. 3M high grip tape in the back side for easy installation in aluminium profile.

Perfil recomendado - Recommended profile

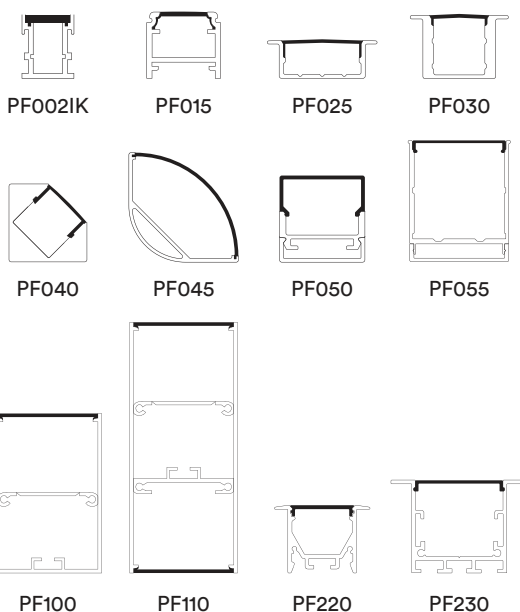

Dimensiones en mm - Dimensions in mm

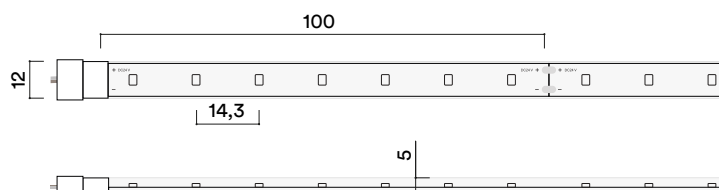

Información técnica - Technical information

*Consultar disponibilidad - Consult availability

					CRI				
SLY4068	4,8W	120°	4000K	550lm/m	90	L70>50.000H	24VDC	19,00€	
SLY3068	4,8W	120°	3000K	460lm/m	90	L70>50.000H	24VDC	19,00€	
SLY2768	4,8W	120°	2700K	405lm/m	90	L70>50.000H	24VDC	19,00€	
SLY2468*	4,8W	120°	2400K	360lm/m	90	L70>50.000H	24VDC	19,00€	

Información adicional - Additional information

Regulación - Dimming



Slp IP20



Dimensiones en mm - Dimensions in mm

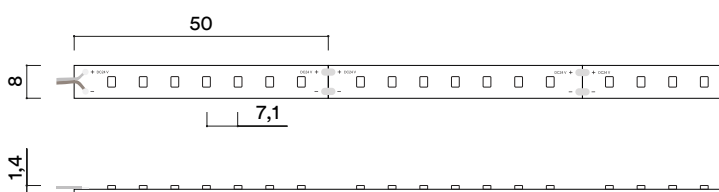

Información técnica - Technical information

						CRI			
SLP5020*		9,6W	120°	5000K	1160lm/m	90	L70>50.000H	24VDC	17,80€
SLP4020		9,6W	120°	4000K	1150lm/m	90	L70>50.000H	24VDC	7,80€
SLP3020		9,6W	120°	3000K	1115lm/m	90	L70>50.000H	24VDC	7,80€
SLP2720		9,6W	120°	2700K	1080lm/m	90	L70>50.000H	24VDC	7,80€
SLP2420*		9,6W	120°	2400K	995lm/m	90	L70>50.000H	24VDC	17,80€
SLP2220*		9,6W	120°	2200K	965lm/m	90	L70>50.000H	24VDC	17,80€

Información adicional - Additional information



Regulación - Dimming



Descripción - Description

Tira de LED flexible de 9,6W/m y 140 LED/m. Adhesivo 3M en la parte posterior para su fácil instalación en perfil de aluminio.

Flexible LED strip with 9,6W/m and 140 LED/m. 3M high grip tape in the back side for easy installation in aluminium profile.

Perfil recomendado - Recommended profile

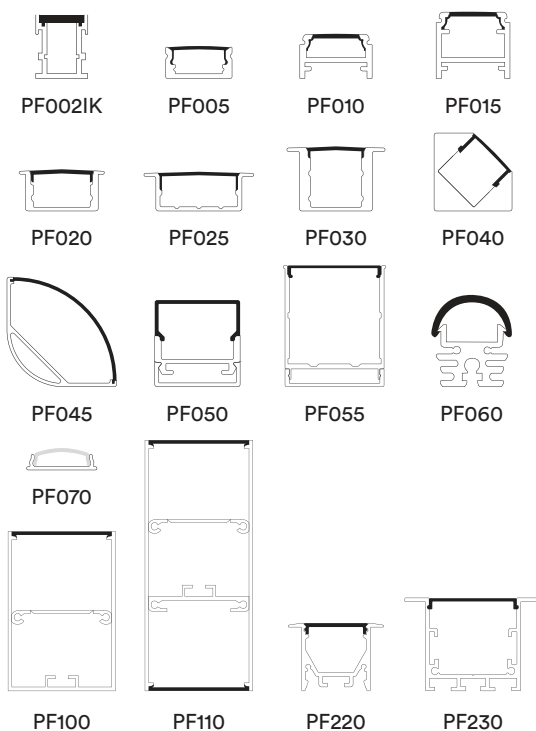

*Consultar disponibilidad - Consult availability

*Stock habitual

Slp IP62

ALEALED



Dimensiones en mm - Dimensions in mm

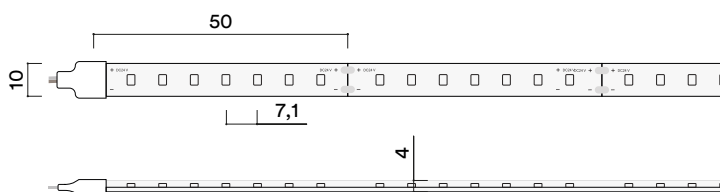

Descripción - Description

Tira de LED flexible de 9,6W/m y 140 LED/m. Adhesivo 3M en la parte posterior para su fácil instalación en perfil de aluminio.

Flexible LED strip with 9,6W/m and 140 LED/m. 3M high grip tape in the back side for easy installation in aluminium profile.

Perfil recomendado - Recommended profile

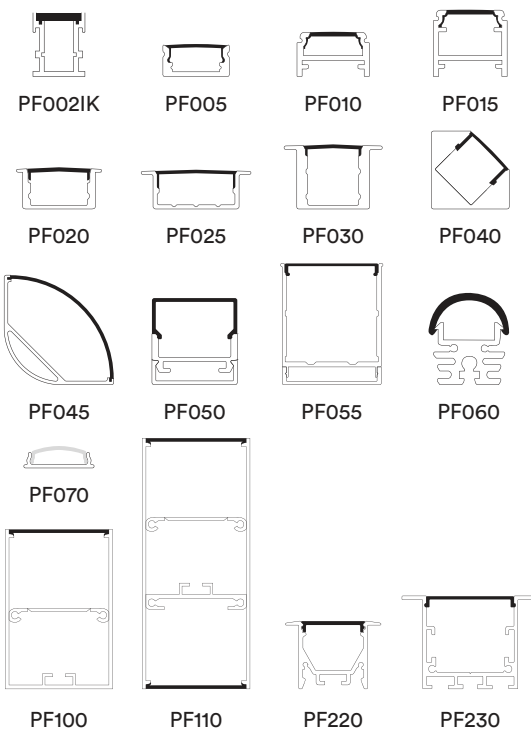

Información técnica - Technical information

*Consultar disponibilidad - Consult availability

					CRI			
SLP5062*	9,6W	120°	5000K	1150lm/m	90	L70>50.000H	24VDC	19,00€
SLP4062	9,6W	120°	4000K	1140lm/m	90	L70>50.000H	24VDC	*19,00€
SLP3062	9,6W	120°	3000K	1060lm/m	90	L70>50.000H	24VDC	*19,00€
SLP2762	9,6W	120°	2700K	1030lm/m	90	L70>50.000H	24VDC	*19,00€
SLP2462*	9,6W	120°	2400K	975lm/m	90	L70>50.000H	24VDC	19,00€
SLP2262*	9,6W	120°	2200K	945lm/m	90	L70>50.000H	24VDC	19,00€

Información adicional - Additional information

Regulación - Dimming



*Stock habitual

Slp IP68



Descripción - Description

Tira de LED flexible de 9,6W/m y 140 LED/m. Adhesivo 3M en la parte posterior para su fácil instalación en perfil de aluminio.

Flexible LED strip with 9,6W/m and 140 LED/m. 3M high grip tape in the back side for easy installation in aluminium profile.

Perfil recomendado - Recommended profile

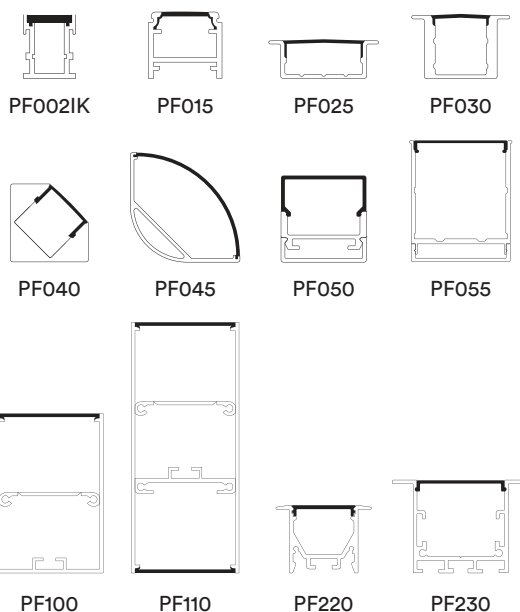

Dimensiones en mm - Dimensions in mm

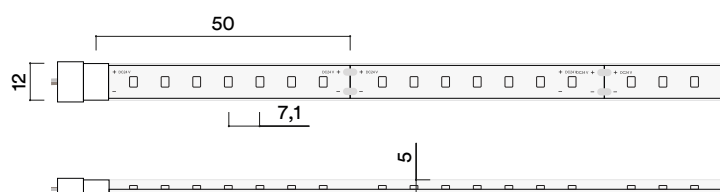

Información técnica - Technical information

**Consultar disponibilidad - Consult availability*

					CRI				
SLP4068	9,6W	120°	4000K	980lm/m	90	L70>50.000H	24VDC	28,30€	
SLP3068	9,6W	120°	3000K	950lm/m	90	L70>50.000H	24VDC	28,30€	
SLP2768	9,6W	120°	2700K	915lm/m	90	L70>50.000H	24VDC	28,30€	
SLP2468*	9,6W	120°	2400K	820lm/m	90	L70>50.000H	24VDC	28,30€	

Información adicional - Additional information

Regulación - Dimming



SIs IP20

ALEALed



Dimensiones en mm - Dimensions in mm

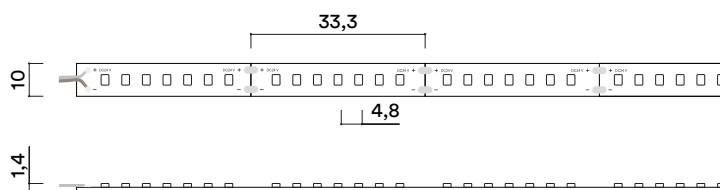

Descripción - Description

Tira de LED flexible de 14,4W/m y 210 LED/m. Adhesivo 3M en la parte posterior para su fácil instalación en perfil de aluminio.

Flexible LED strip with 14,4W/m and 210 LED/m. 3M high grip tape in the back side for easy installation in aluminium profile.

Perfil recomendado - Recommended profile

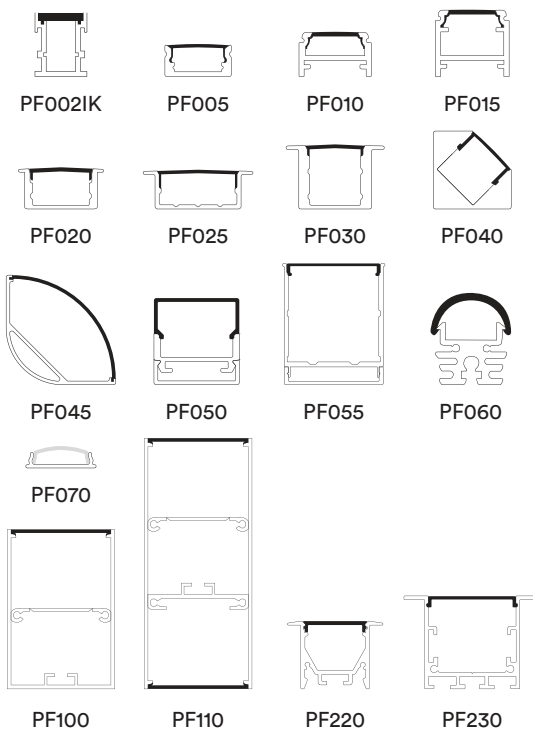

Información técnica - Technical information

*Consultar disponibilidad - Consult availability

					CRI			
SLS5020*	14,4W	120°	5000K	1750lm/m	90	L70>50.000H	24VDC	22,50€
SLS4020	14,4W	120°	4000K	1740lm/m	90	L70>50.000H	24VDC	*22,50€
SLS3020	14,4W	120°	3000K	1680lm/m	90	L70>50.000H	24VDC	*22,50€
SLS2720	14,4W	120°	2700K	1630lm/m	90	L70>50.000H	24VDC	*22,50€
SLS2420*	14,4W	120°	2400K	1555lm/m	90	L70>50.000H	24VDC	22,50€
SLS2220*	14,4W	120°	2200K	1270lm/m	90	L70>50.000H	24VDC	22,50€

Información adicional - Additional information

Regulación - Dimming



*Stock habitual

SIs IP62



Descripción - Description

Tira de LED flexible de 14,4W/m y 210 LED/m. Adhesivo 3M en la parte posterior para su fácil instalación en perfil de aluminio.

Flexible LED strip with 14,4W/m and 210 LED/m. 3M high grip tape in the back side for easy installation in aluminium profile.

Perfil recomendado - Recommended profile

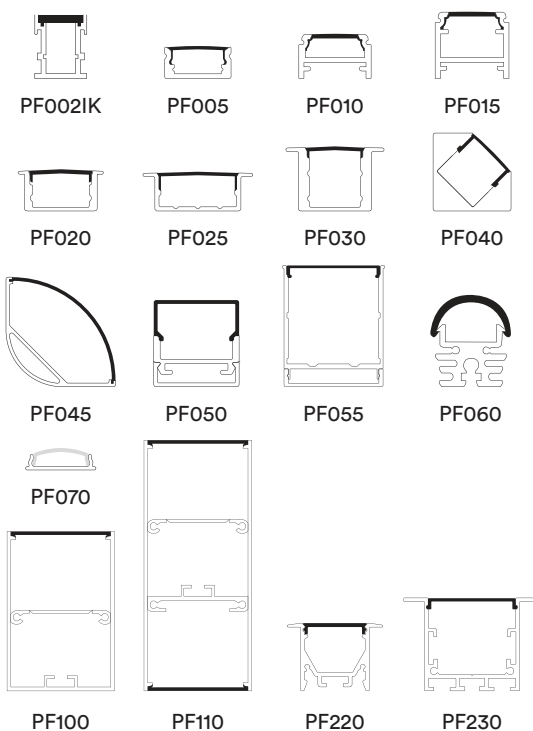

Dimensiones en mm - Dimensions in mm

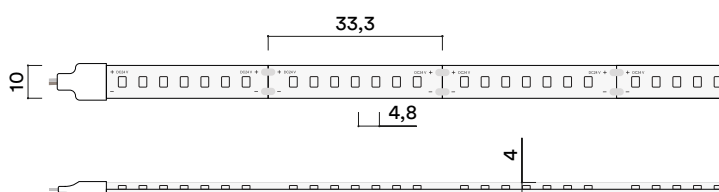

Información técnica - Technical information

*Consultar disponibilidad - Consult availability

	⚡	∠	🌡️	☀️	CRI	🕒		
SLS5062*	14,4W	120°	5000K	1510lm/m	90	L70>50.000H	24VDC	23,60€
SLS4062	14,4W	120°	4000K	1480lm/m	90	L70>50.000H	24VDC	*23,60€
SLS3062	14,4W	120°	3000K	1400lm/m	90	L70>50.000H	24VDC	*23,60€
SLS2762	14,4W	120°	2700K	1250lm/m	90	L70>50.000H	24VDC	*23,60€
SLS2462*	14,4W	120°	2400K	1000lm/m	90	L70>50.000H	24VDC	23,60€
SLS2262*	14,4W	120°	2200K	900lm/m	90	L70>50.000H	24VDC	23,60€

Información adicional - Additional information

Regulación - Dimming



*Stock habitual

Sls IP68

ALEALED



Descripción - Description

Tira de LED flexible de 14,4W/m y 210 LED/m. Adhesivo 3M en la parte posterior para su fácil instalación en perfil de aluminio.

Flexible LED strip with 14,4W/m and 210 LED/m. 3M high grip tape in the back side for easy installation in aluminium profile.

Perfil recomendado - Recommended profile

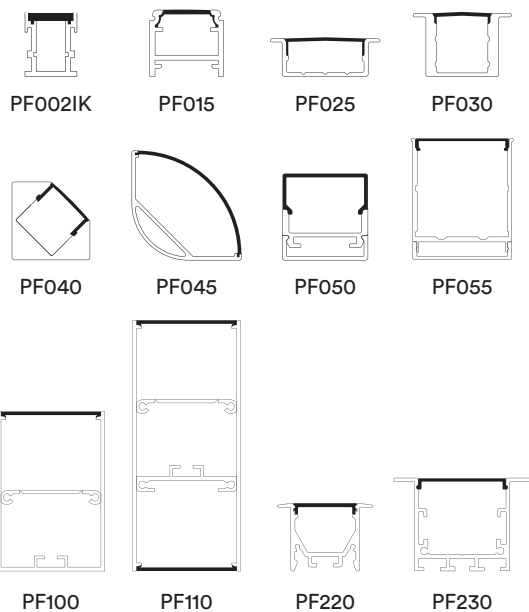

Dimensiones en mm - Dimensions in mm

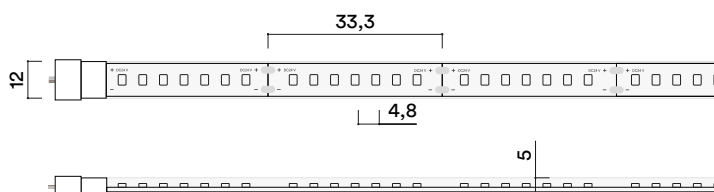

Información técnica - Technical information

**Consultar disponibilidad - Consult availability*

					CRI			
SLS4068	14,4W	120°	4000K	1480lm/m	90	L70>50.000H	24VDC	29,50€
SLS3068	14,4W	120°	3000K	1400lm/m	90	L70>50.000H	24VDC	29,50€
SLS2768	14,4W	120°	2700K	1250lm/m	90	L70>50.000H	24VDC	29,50€
SLS2468*	14,4W	120°	2400K	1000lm/m	90	L70>50.000H	24VDC	29,50€

Información adicional - Additional information

Regulación - Dimming



SLx IP20



Descripción - Description

Tira de LED flexible de 19,2W/m y 240 LED/m. Adhesivo 3M en la parte posterior para su fácil instalación en perfil de aluminio.

Flexible LED strip with 19,2W/m and 240 LED/m. 3M high grip tape in the back side for easy installation in aluminium profile.

Perfil recomendado - Recommended profile

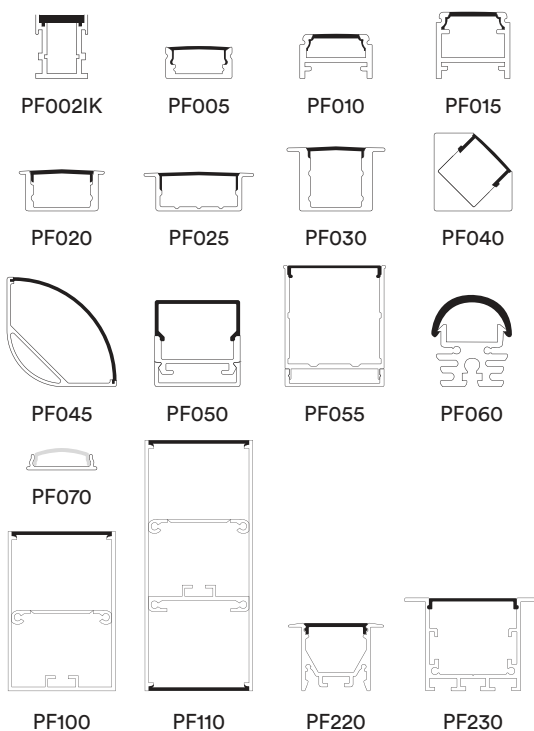

Dimensiones en mm - Dimensions in mm

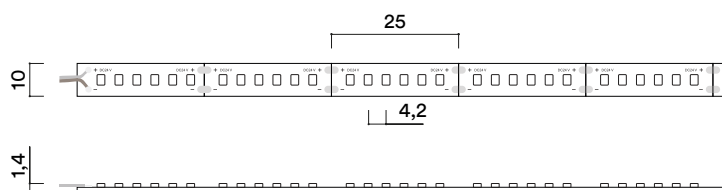

Información técnica - Technical information

*Consultar disponibilidad - Consult availability

	⚡	∠	🌡️	☀️	CRI	🕒		
SLX5020*	19,2W	120°	5000K	1880lm/m	90	L70>50.000H	24VDC	35,40€
SLX4020	19,2W	120°	4000K	1860lm/m	90	L70>50.000H	24VDC	35,40€
SLX3020	19,2W	120°	3000K	1800lm/m	90	L70>50.000H	24VDC	35,40€
SLX2720	19,2W	120°	2700K	1740lm/m	90	L70>50.000H	24VDC	35,40€
SLX2420*	19,2W	120°	2400K	1680lm/m	90	L70>50.000H	24VDC	35,40€
SLX2220*	19,2W	120°	2200K	1380lm/m	90	L70>50.000H	24VDC	35,40€

Información adicional - Additional information

Regulación - Dimming



SLV IP20

ALEALed



Dimensiones en mm - Dimensions in mm

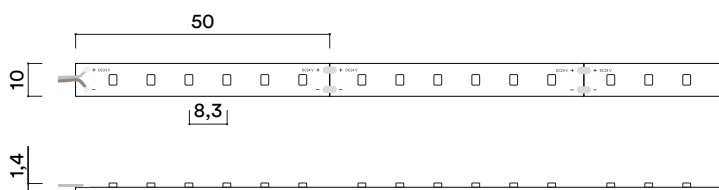

Descripción - Description

Tira de LED flexible de 28,8W/m y 120 LED/m. Adhesivo 3M en la parte posterior para su fácil instalación en perfil de aluminio.

Flexible LED strip with 28,8W/m and 120 LED/m. 3M high grip tape in the back side for easy installation in aluminium profile.

Perfil recomendado - Recommended profile

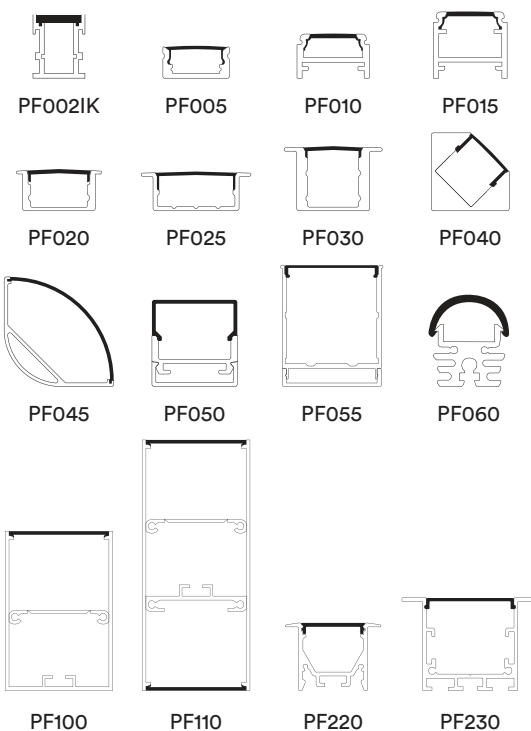

Información técnica - Technical information

*Consultar disponibilidad - Consult availability

					CRI			
SLV5020*	28,8W	120°	5000K	2690lm/m	90	L70>50.000H	24VDC	44,80€
SLV4020	28,8W	120°	4000K	2530lm/m	90	L70>50.000H	24VDC	44,80€
SLV3020	28,8W	120°	3000K	2405lm/m	90	L70>50.000H	24VDC	44,80€
SLV2720	28,8W	120°	2700K	2375lm/m	90	L70>50.000H	24VDC	44,80€
SLV2420*	28,8W	120°	2400K	2345lm/m	90	L70>50.000H	24VDC	44,80€
SLV2220*	28,8W	120°	2200K	2215lm/m	90	L70>50.000H	24VDC	44,80€

Información adicional - Additional information

Regulación - Dimming



SLV IP62



Descripción - Description

Tira de LED flexible de 28,8W/m y 120 LED/m. Adhesivo 3M en la parte posterior para su fácil instalación en perfil de aluminio.

Flexible LED strip with 28,8W/m and 120 LED/m. 3M high grip tape in the back side for easy installation in aluminium profile.

Perfil recomendado - Recommended profile

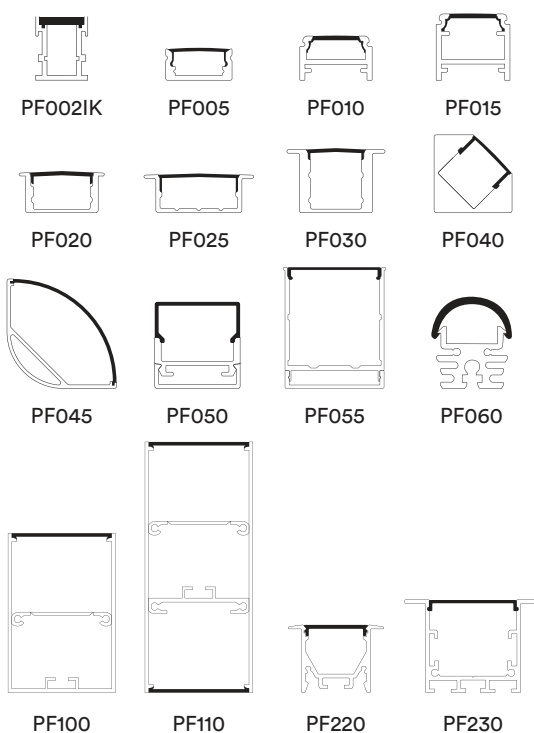

Dimensiones en mm - Dimensions in mm

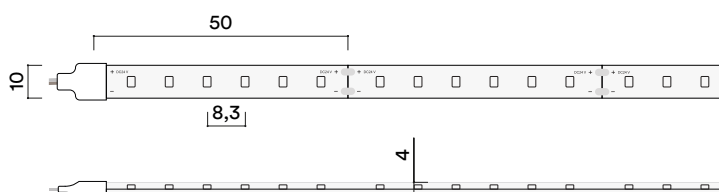

Información técnica - Technical information

*Consultar disponibilidad - Consult availability

Icono	Wattaje	Ángulo	Temperatura de Color	Luminancia	CRI	Alargamiento	Voltaje	Precio
⊕	28,8W	120°	5000K	2640lm/m	90	L70>50.000H	24VDC	49,50€
⚡	28,8W	120°	4000K	2485lm/m	90	L70>50.000H	24VDC	49,50€
∠	28,8W	120°	3000K	2360lm/m	90	L70>50.000H	24VDC	49,50€
🌡️	28,8W	120°	2700K	2330lm/m	90	L70>50.000H	24VDC	49,50€
☀️	28,8W	120°	2400K	2295lm/m	90	L70>50.000H	24VDC	49,50€
🕒	28,8W	120°	2200K	2170lm/m	90	L70>50.000H	24VDC	49,50€

Información adicional - Additional information

Regulación - Dimming



SLV IP68

ALEALed



Descripción - Description

Tira de LED flexible de 28,8W/m y 120 LED/m. Adhesivo 3M en la parte posterior para su fácil instalación en perfil de aluminio.

Flexible LED strip with 28,8W/m and 120 LED/m. 3M high grip tape in the back side for easy installation in aluminium profile.

Perfil recomendado - Recommended profile

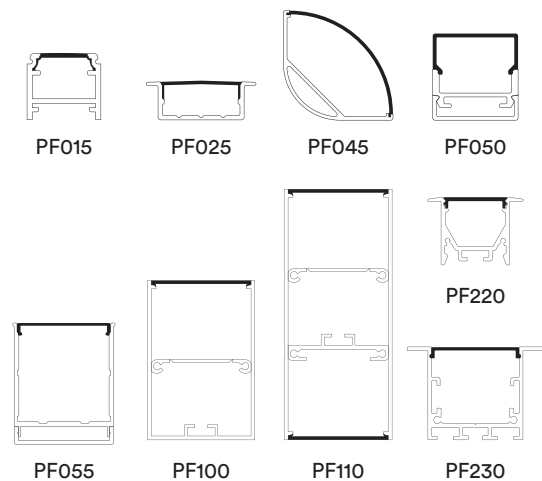

Dimensiones en mm - Dimensions in mm

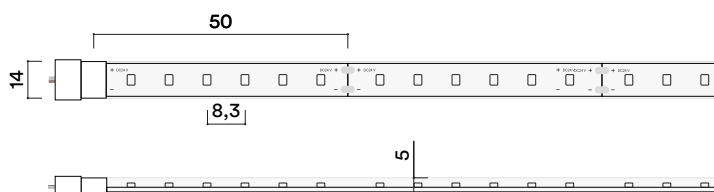

Información técnica - Technical information

*Consultar disponibilidad - Consult availability

					CRI			
SLV4068	28,8W	120°	4000K	2185lm/m	90	L70>50.000H	24VDC	57,80€
SLV3068	28,8W	120°	3000K	2130lm/m	90	L70>50.000H	24VDC	57,80€
SLV2768	28,8W	120°	2700K	2010lm/m	90	L70>50.000H	24VDC	57,80€
SLV2468*	28,8W	120°	2400K	1980lm/m	90	L70>50.000H	24VDC	57,80€

Información adicional - Additional information

Regulación - Dimming

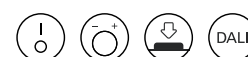

SLz IP20



Descripción - Description

Tira de LED flexible de 38,4W/m y 180 LED/m. Adhesivo 3M en la parte posterior para su fácil instalación en perfil de aluminio.

Flexible LED strip with 38,4W/m and 180 LED/m. 3M high grip tape in the back side for easy installation in aluminium profile.

Perfil recomendado - Recommended profile

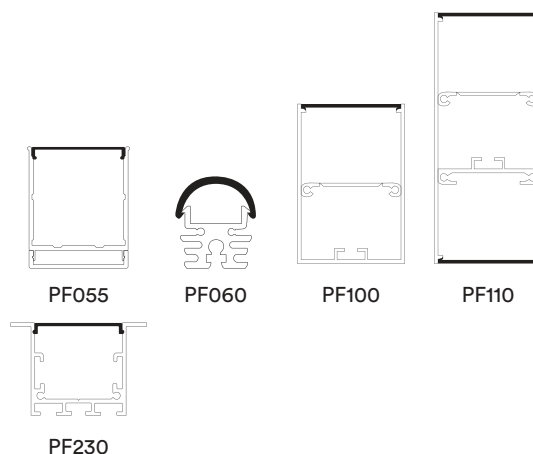

Dimensiones en mm - Dimensions in mm



Información técnica - Technical information

					CRI			
SLZ0003	38,4W	120°	4100K	3870lm/m	90	L70>50.000H	24VDC	54,30€
SLZ0002	38,4W	120°	2700K	3600lm/m	90	L70>50.000H	24VDC	54,30€
SLZ0001	38,4W	120°	2200K	3247lm/m	90	L70>50.000H	24VDC	54,30€

Información adicional - Additional information

Regulación - Dimming



SLd IP20

ALEALed



Descripción - Description

Tira de LED flexible de 9,6W/m y 120 LED/m en su versión blanco dinámico. Adhesivo 3M en la parte posterior para su fácil instalación en perfil de aluminio.

Dynamic white flexible LED strip with 9,6W/m and 120 LED/m. 3M high grip tape in the back side for easy installation in aluminium profile.

Perfil recomendado - Recommended profile

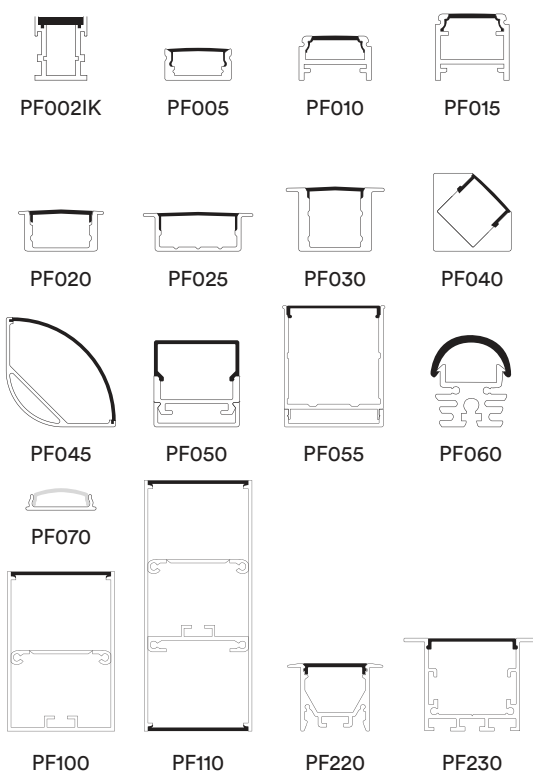

Dimensiones en mm - Dimensions in mm



Información técnica - Technical information

	⚡	∠	°K	☀	CRI	🕒			
SLD204020	9,6W	120°	2000K-4000K	330lm – 500lm	90	L70>50.000H	24VDC	28,10€	
SLD203020	9,6W	120°	2000K-3000K	-	90	L70>50.000H	24VDC	28,10€	
SLD202720	9,6W	120°	2000K-2700K	-	90	L70>50.000H	24VDC	28,10€	

Información adicional - Additional information

Regulación - Dimming



SLF IP20



Dimensiones en mm - Dimensions in mm

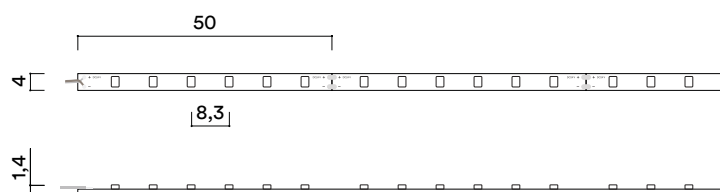

Descripción - Description

Tira de LED flexible de 7,2W/m y 120 LED/m. Adhesivo 3M en la parte posterior para su fácil instalación en perfil de aluminio.

Flexible LED strip with 7,2W/m and 120 LED/m. 3M high grip tape in the back side for easy installation in aluminium profile.

Perfil recomendado - Recommended profile

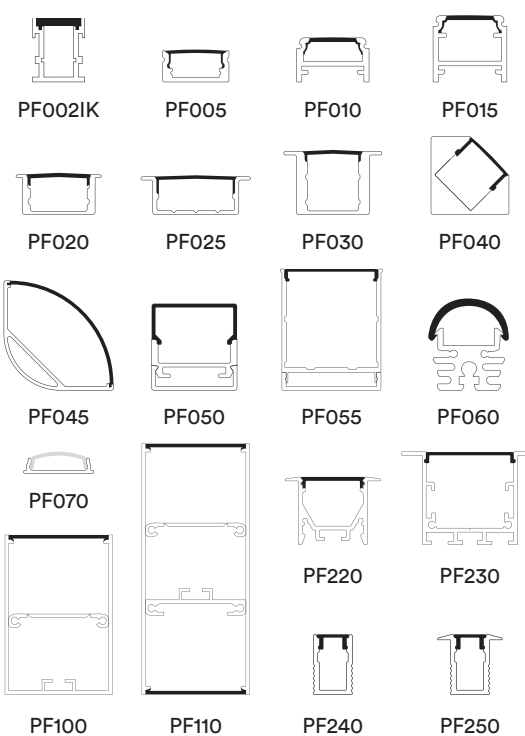

Información técnica - Technical information

	⚡	∠	🌡️	☀️	CRI	🕒			
SLF4020	7,2W	120°	4000K	620lm/m	90	L70>50.000H	24VDC	19,70€	
SLF3020	7,2W	120°	3000K	580lm/m	90	L70>50.000H	24VDC	19,70€	
SLF2720	7,2W	120°	2700K	530lm/m	90	L70>50.000H	24VDC	19,70€	

Información adicional - Additional information



Regulación - Dimming



Slr IP20

ALEALed

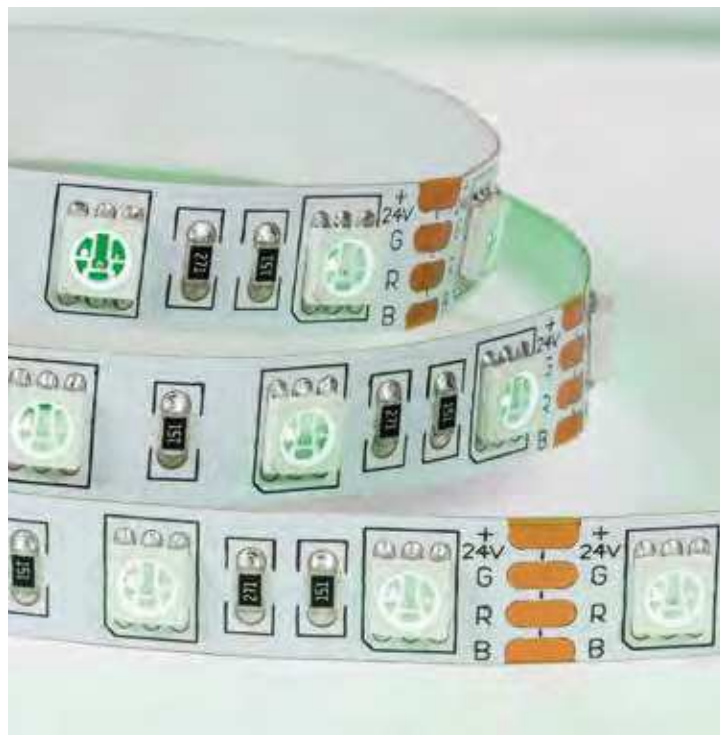

Dimensiones en mm - Dimensions in mm

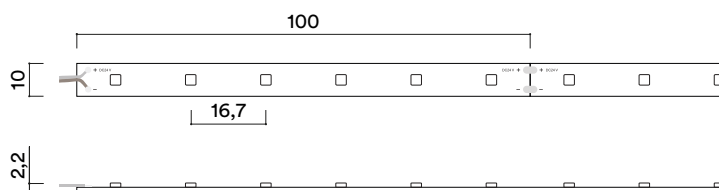

Descripción - Description

Tira de LED flexible de 14,4W/m (RGB) o 19,2W/m (RGBW) y 60 LED/m. Adhesivo 3M en la parte posterior para su fácil instalación en perfil de aluminio.

Flexible LED strip with 14,4W/m (RGB) or 19,2W/m (RGBW) and 60 LED/m. 3M high grip tape in the back side for easy installation in aluminium profile.

Perfil recomendado - Recommended profile

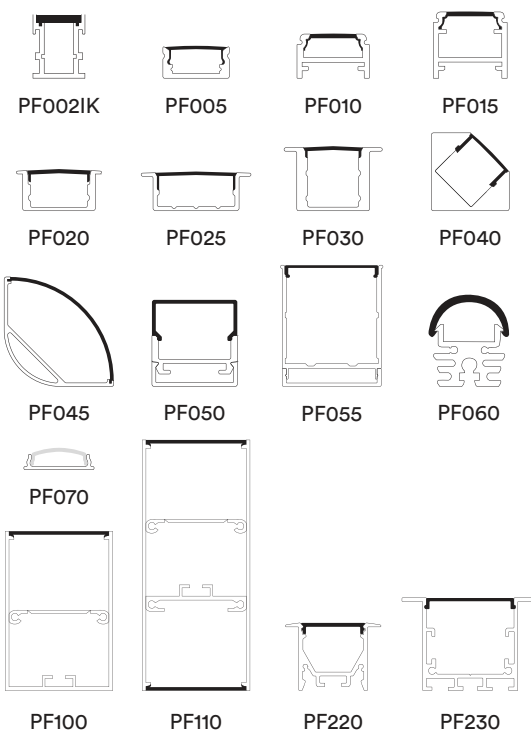

Información técnica - Technical information

	⚡	∠	🌡️	☀️	CRI	🕒	
SLR0003	14,4W	120°	RGB	-	-	L70>50.000H	24VDC
SLR0011	19,2W	120°	RGB+2700K	-	90	L70>50.000H	24VDC

Información adicional - Additional information

Regulación - Dimming



Slr IP62

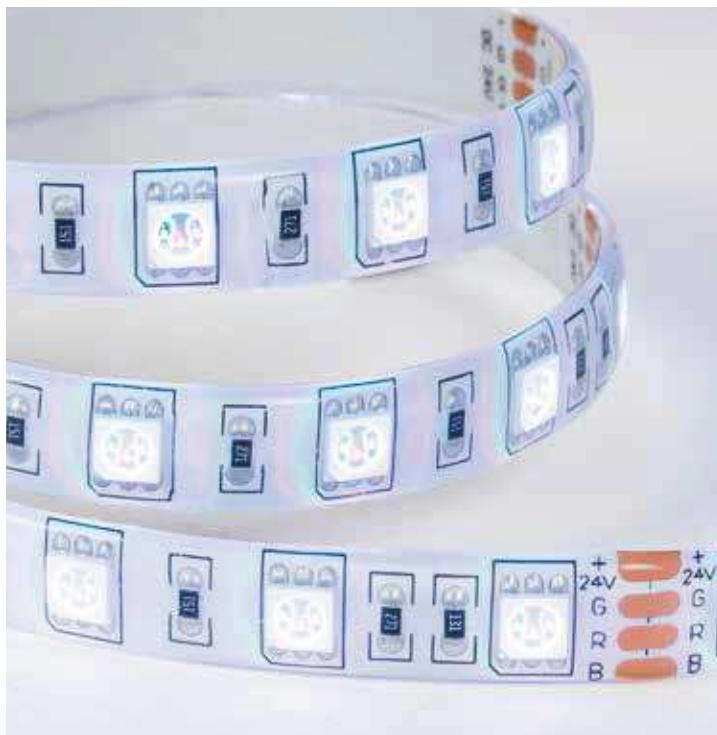

Dimensiones en mm - Dimensions in mm

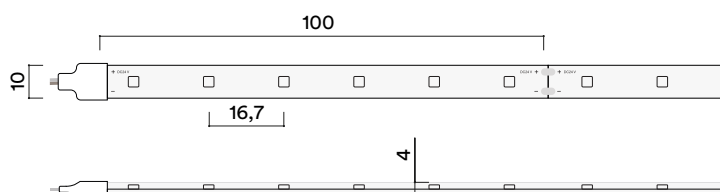

Descripción - Description

Tira de LED flexible de 14,4W/m (RGB) y 60 LED/m. Adhesivo 3M en la parte posterior para su fácil instalación en perfil de aluminio.

Flexible LED strip with 14,4W/m (RGB) and 60 LED/m. 3M high grip tape in the back side for easy installation in aluminium profile.

Perfil recomendado - Recommended profile

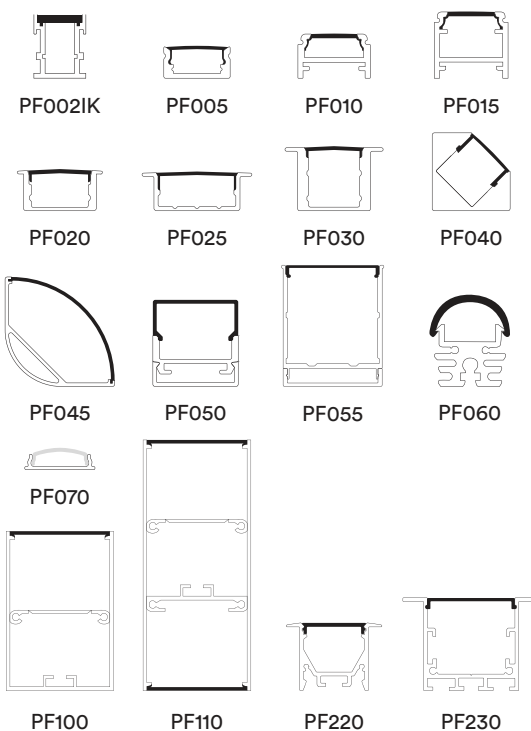

Información técnica - Technical information

SLR0002	14,4W	120°	RGB	-	L70 > 50.000H	24VDC	33,00€

Información adicional - Additional information



Regulación - Dimming



Slr IP68

ALEALed



Descripción - Description

Tira de LED flexible de 14,4W/m (RGB) o 19,2W/m (RGBW) y 60 LED/m. Adhesivo 3M en la parte posterior para su fácil instalación en perfil de aluminio.

Flexible LED strip with 14,4W/m (RGB) or 19,2W/m (RGBW) and 60 LED/m. 3M high grip tape in the back side for easy installation in aluminium profile.

Perfil recomendado - Recommended profile

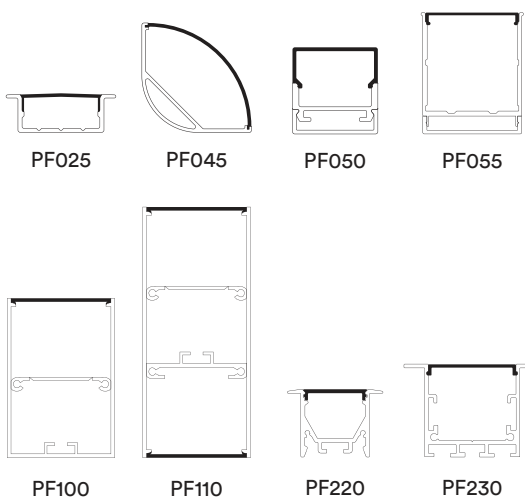

Dimensiones en mm - Dimensions in mm

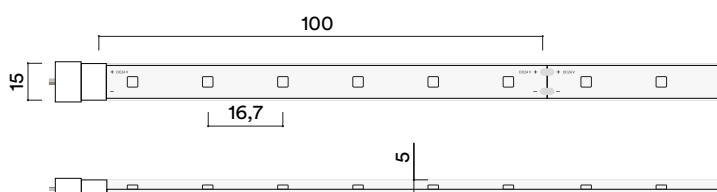

Información técnica - Technical information

	⚡	∠	°K	☀	CRI	🕒		
SLR0008	14,4W	120°	RGB	-	-	L70>50.000H	24VDC	35,40€
SLR0012	19,2W	120°	RGB+2700K	-	90	L70>50.000H	24VDC	40,10€

Información adicional - Additional information

Regulación - Dimming



SII IP20



Descripción - Description

Tira digital de LED flexible de 14,4W/m y 60 LED/m. Adhesivo 3M en la parte posterior para su fácil instalación en perfil de aluminio.

Digital flexible LED strip with 14,4W/m and 120 LED/m. 3M high grip tape in the back side for easy installation in aluminium profile.

Perfil recomendado - Recommended profile

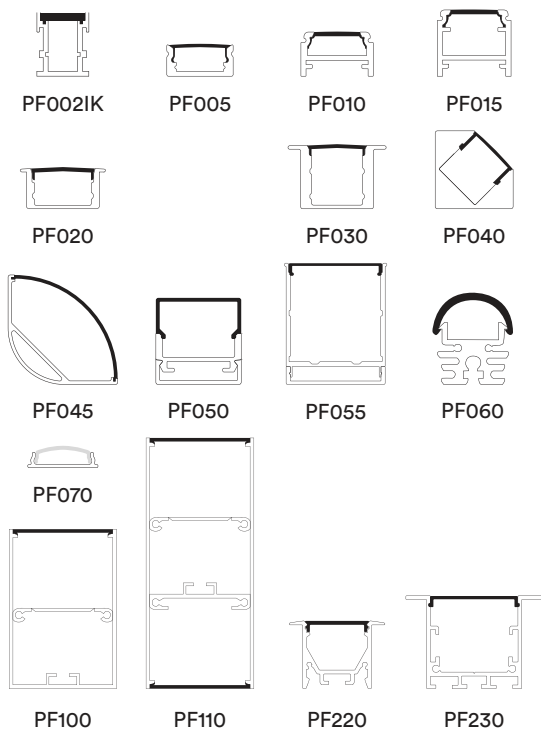

Dimensiones en mm - Dimensions in mm

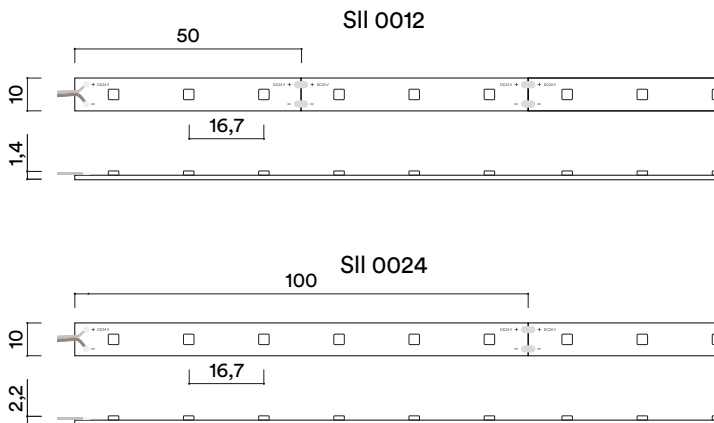

Información técnica - Technical information

Model	Power (W)	Beam Angle (°)	Color	Dimming	CRI	Life (h)	Voltage (VDC)	Price (€)
SLL0012	14,4W	120°	RGB	-	-	L70>50.000H	24VDC	46,00€
SLL0024	14,4W	120°	RGB	-	-	L70>50.000H	24VDC	46,00€

Información adicional - Additional information

Regulación - Dimming



SLH IP20

ALEALED

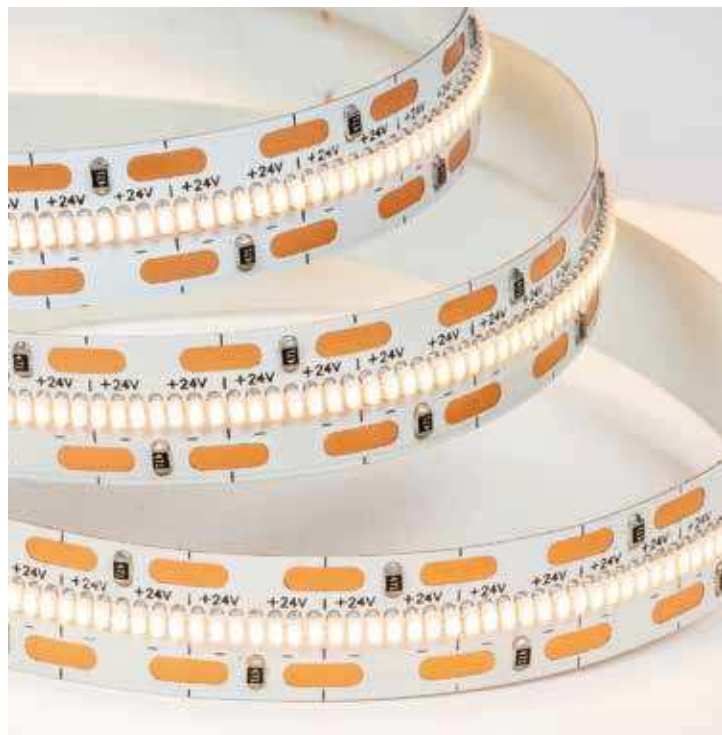

Descripción - Description

Tira de LED flexible de 18W/m y 700 LED/m. Adhesivo 3M en la parte posterior para su fácil instalación en perfil de aluminio.

Flexible LED strip with 18W/m and 700 LED/m. 3M high grip tape in the back side for easy installation in aluminium profile.

Perfil recomendado - Recommended profile

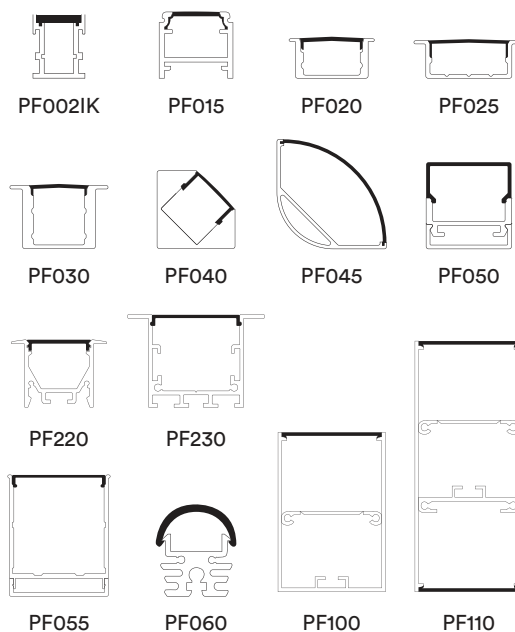

Dimensiones en mm - Dimensions in mm

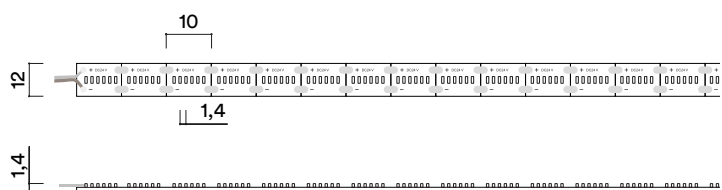

Información técnica - Technical information

					CRI			
SLH4020	18W	120°	4000K	1927lm/m	90	L70>50.000H	24VDC	29,50€
SLH3020	18W	120°	3000K	1864lm/m	90	L70>50.000H	24VDC	29,50€
SLH2720	18W	120°	2700K	1804lm/m	90	L70>50.000H	24VDC	29,50€

Información adicional - Additional information



Regulación - Dimming



SLN IP67



Descripción - Description

Neón LED flexible de 12,0W/m y 120 LED/m.

Flexible LED neon strip with 12,0W/m and 120 LED/m.

Accesorios - Accessories

SLNAG
Tapa con agujero
End cap with hole



SLNEC
Tapa final
End cap

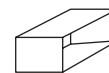

SLNSP
Soporte
Bracket

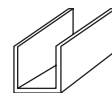

Dimensiones en mm - Dimensions in mm

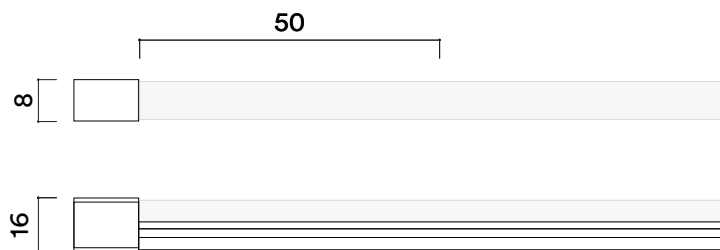

Información técnica - Technical information

					CRI			
SLN4067	12W	120°	4000K	480lm/m	90	L70>50.000H	24VDC	37,80€
SLN3067	12W	120°	3000K	435lm/m	90	L70>50.000H	24VDC	37,80€
SLN2767	12W	120°	2700K	420lm/m	90	L70>50.000H	24VDC	37,80€

Información adicional - Additional information



Regulación - Dimming



SLA IP67

ALEALed



Descripción - Description

Neón LED flexible extra fino de 9,6W/m y 120 LED/m.

Flexible extra thin LED neon strip with 9,6W/m and 120 LED/m.

Accesorios - Accessories

SLAAG
Tapa con agujero
End cap with hole

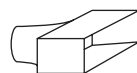

SLAEC
Tapa final
End cap

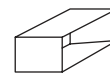

SLNSP
Soporte
Bracket

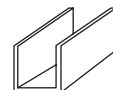

Dimensiones en mm - Dimensions in mm

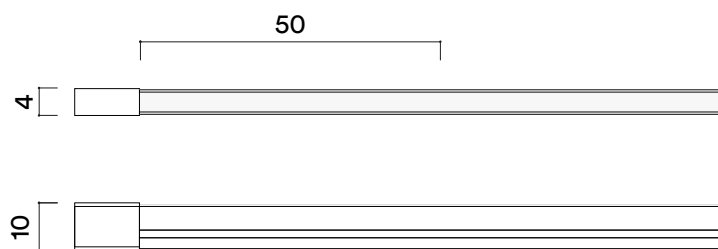

Información técnica - Technical information

					CRI			
SLA4067	9,6W	120°	4000K	385lm/m	90	L70>50.000H	24VDC	26,90€
SLA3067	9,6W	120°	3000K	350lm/m	90	L70>50.000H	24VDC	26,90€
SLA2767	9,6W	120°	2700K	335lm/m	90	L70>50.000H	24VDC	26,90€

Información adicional - Additional information

Regulación - Dimming



Sle IP65



Descripción - Description

Neón LED tubular flexible de 11,0W/m y 360 LED/m.

Flexible tubular LED neon strip with 11,0W/m and 360 LED/m.

Accesorios - Accessories

SLECX
Conector
Connector

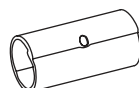



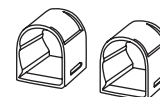

SLNCL
Clip
Clip



Dimensiones en mm - Dimensions in mm



Información técnica - Technical information

					CRI			
SLE4065	11W	360°	4000K	770lm/m	70	L70>50.000H	24VDC	80,10€
SLE3065	11W	360°	3000K	750lm/m	70	L70>50.000H	24VDC	80,10€
SLE2765	11W	360°	2700K	720lm/m	70	L70>50.000H	24VDC	80,10€

Información adicional - Additional information



Regulación - Dimming



Ledstrip

ALEALed

Pf005



Dimensiones en mm
Dimensions in mm

6,50€

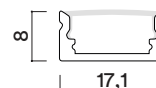

Accesorios - Accessories

PF006 4,80€
Difusor opal
Opal diffuser

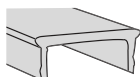

PF007 4,80€
Difusor transparente
Transparent diffuser



PF008/PF009 2,50€
Tapa final con/sin agujero
End cap with/ without hole

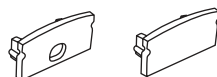

PF023 1,50€
Soporte perfil
Bracket profile



PF024 3,00€
Soporte basculante
Tilting bracket

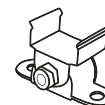

Pf010



Dimensiones en mm
Dimensions in mm

7,20€

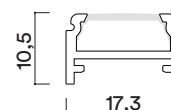

Accesorios - Accessories

PF011 4,80€
Difusor opal
Opal diffuser

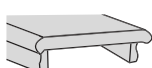

PF012 4,80€
Difusor transparente
Transparent diffuser



PF013 2,50€
Tapa final
End cap

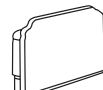

PF014 1,00€
Soporte perfil
Bracket profile

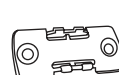

PF024 3,00€
Soporte basculante
Tilting bracket

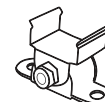

Pf015

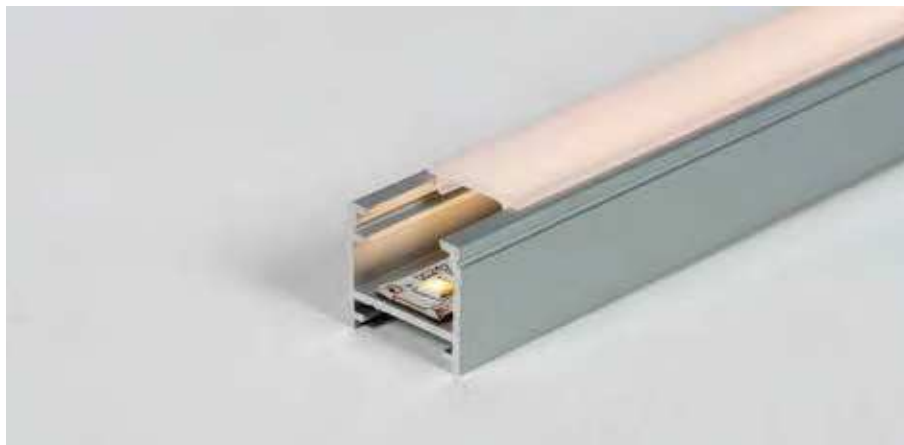

Dimensiones en mm
Dimensions in mm

7,70€

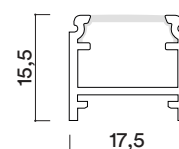

Accesorios - Accessories

PF011 4,80€
Difusor opal
Opal diffuser

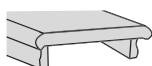

PF012 4,80€
Difusor transparente
Transparent diffuser

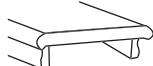

PF013 2,50€
Tapa final
End cap



PF014 1,00€
Soporte perfil
Bracket profile



Pf020



Dimensiones en mm
Dimensions in mm

8,30€

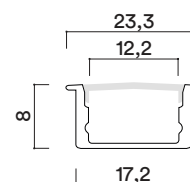

Accesorios - Accessories

PF004 4,80€
Difusor glaseado
Glazed diffuser



PF044 8,30€
Difusor transparente
Transparent diffuser



PF021/PF022 2,50€
Tapa final con/sin agujero
End cap with/ without hole



PF023 1,50€
Soporte perfil
Bracket profile



Ledstrip

ALEALed

Pf025



Dimensiones en mm
Dimensions in mm

28,30€

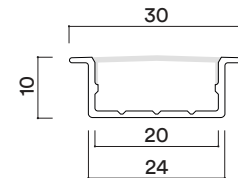

Accesorios - Accessories

INCLUIDO
Difusor opal
Opal diffuser

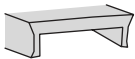

PF026 2,50€
Tapa final con agujero
End cap with hole

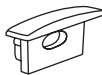

PF027 2,50€
Tapa final sin agujero
End cap without hole

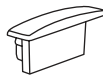

Pf030

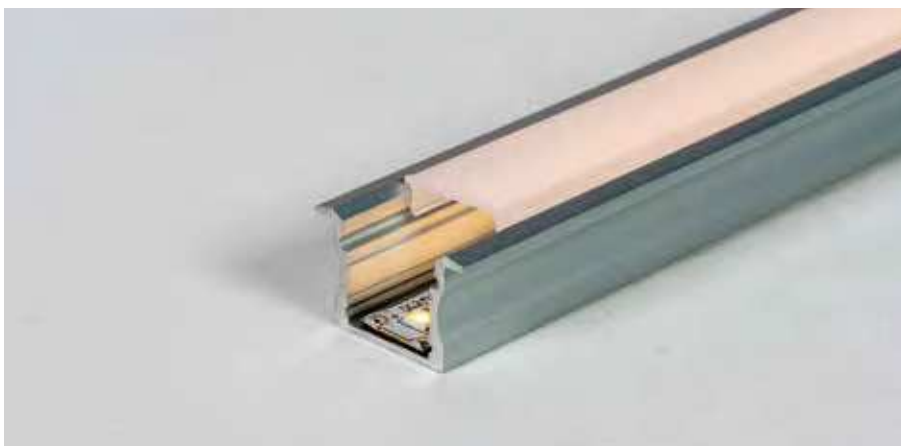

Dimensiones en mm
Dimensions in mm

9,00€

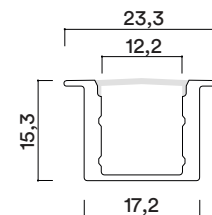

Opción Negro
Full Black option



Accesorios - Accessories

PF006 4,80€
Difusor glaseado
Glazed diffuser



PF007 4,80€
Difusor transparente
Transparent diffuser



PF031/PF032 2,50€
Tapa final con/sin agujero
End cap with/without hole



PF023 1,50€
Soporte perfil
Bracket profile



Pf040



Dimensiones en mm
Dimensions in mm

16,50€

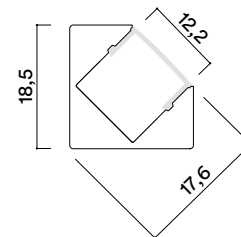

Accesorios - Accessories

PF004 4,80€
Difusor glaseado
Glazed diffuser

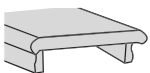

PF044 8,30€
Difusor transparente
Transparent diffuser

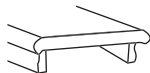

PF041/PF042 2,50€
Tapa final con/sin agujero
End cap with/without hole



PF043 3,70€
Soporte perfil
Bracket profile



Pf045



Dimensiones en mm
Dimensions in mm

40,10€

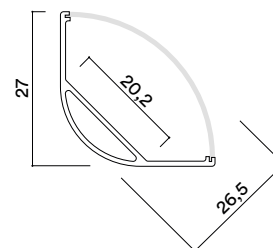

Accesorios - Accessories

INCLUIDO
Difusor opal
Opal diffuser

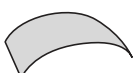

PF046 2,50€
Tapa final con agujero
End cap with hole



PF047 2,50€
Tapa final sin agujero
End cap without hole



PF048 3,70€
Soporte perfil
Bracket profile

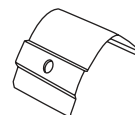

Ledstrip

ALEALed

Pf050



Dimensiones en mm
Dimensions in mm

21,30€

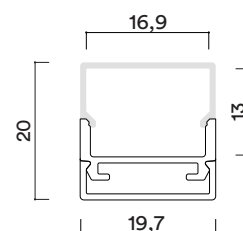

Accesorios - Accessories

INCLUIDO
Difusor opal
Opal diffuser



PF051 2,50€
Tapa final con agujero
End cap with hole



PF052 2,50€
Tapa final sin agujero
End cap without hole



Pf055



Dimensiones en mm
Dimensions in mm

29,50€

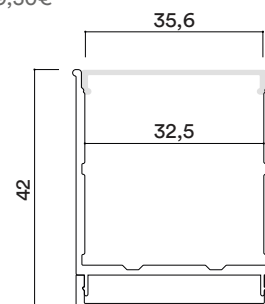

Accesorios - Accessories

PF058 9,00€
Difusor opal
Opal diffuser

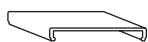

PF056 2,50€
Tapa final con agujero
End cap with hole



PF057 2,50€
Tapa final sin agujero
End cap without hole



Pf060

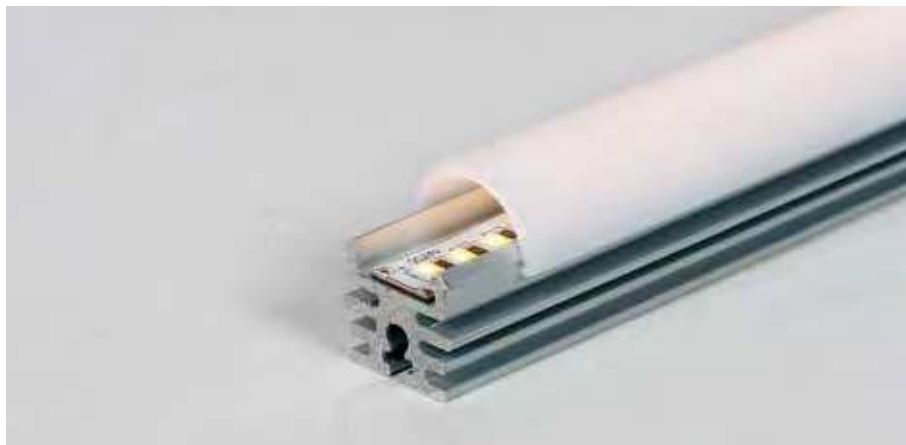

Dimensiones en mm

Dimensions in mm

40,30€

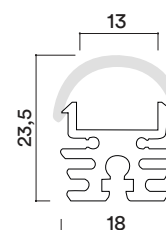

Accesorios - Accessories

INCLUIDO

Difusor opal
Opal diffuser



PF061 2,50€

Tapa final con agujero
End cap with hole



PF062 2,50€

Tapa final sin agujero
End cap without hole



PF063 2,50€

Soporte perfil
Bracket profile



Pf070



Dimensiones en mm

Dimensions in mm

9,00€

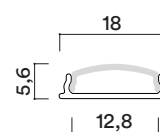

Perfil fino de aluminio flexible - Slim aluminium led profile bendable

Accesorios - Accessories

INCLUIDO

Difusor opal
Opal diffuser



PF072 1,50€

Tapa final con agujero
End cap with hole

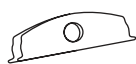

PF073 1,50€

Tapa final sin agujero
End cap without hole



PF074 2,00€

Soporte perfil
Bracket profile



Ledstrip

ALEALed

Pf100



Dimensiones en mm
Dimensions in mm

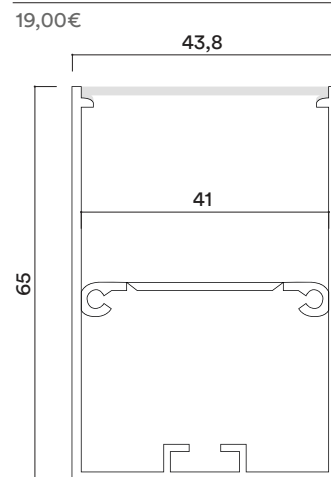

Accesorios - Accessories

PF101 9,50€
Difusor opal
Opal diffuser



PF102 11,80€
Difusor glaseado alto impacto
High impact frosted diffuser

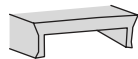

1800309T 14,20€
Tapa final soldada
Welded End cap

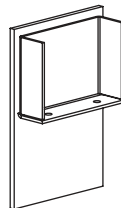

Pf002IK



Dimensiones en mm
Dimensions in mm

61,30€

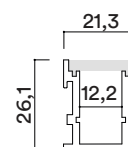

Índice de protección contra
impacto mecánicos: IK08
Impact protection rating: IK08

Accesorios - Accessories

Perfil transitable - Passable profile

INCLUIDO
Difusor opal
Opal diffuser



PF003AG 2,50€
Tapa final con agujero
End cap with hole



PF003S 2,50€
Tapa final sin agujero
End cap without hole

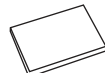

Pf110

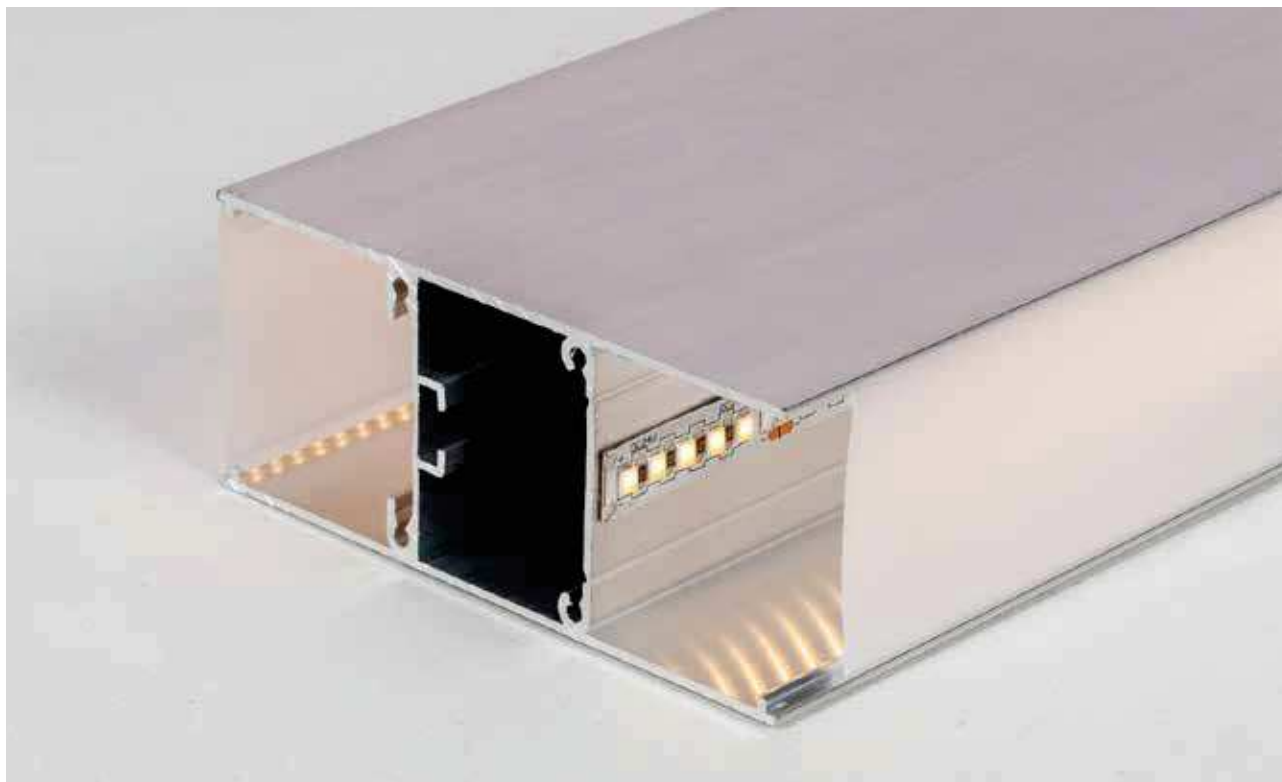

Perfil H en aluminio bruto - H profile in raw aluminum

Dimensiones en mm - Dimensions in mm

23,60€

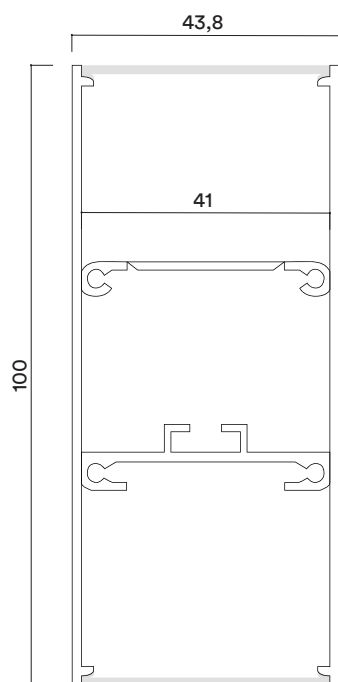

Accesorios - Accessories

PF101 9,50€
Difusor opal
Opal diffuser



PF102 11,80€
Difusor glaseado alto impacto
High impact frosted diffuser



1800309S 10,70€
Tapa final soldada
Welded End cap

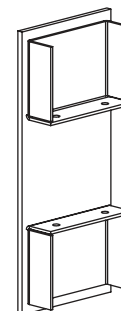

Ledstrip

Pf220



Dimensiones en mm
Dimensions in mm

19,00€

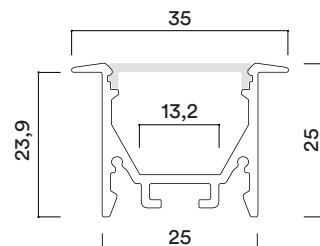

Accesorios - Accessories

INCLUIDO
Difusor opal
Opal diffuser



PF221 3,80€
Tapa final
End cap



PF222 2,80€
Clip montaje
Mounting Clip

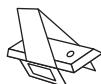

Pf230



Dimensiones en mm
Dimensions in mm

30,70€

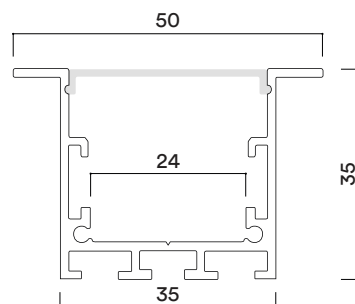

Accesorios - Accessories

PF233 (INCLUIDO)
Difusor opal
Opal diffuser



PF231 4,10€
Tapa final
End cap



PF232 2,90€
Clip montaje
Mounting Clip



Pf240



Dimensiones en mm

Dimensions in mm

16,50€

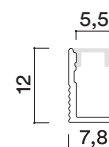

Accesorios - Accessories

PF241 4,80€
Difusor opal
Opal diffuser

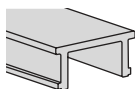

PF242 2,50€
Tapa final sin agujero
End cap without hole

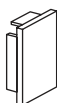

PF243 2,50€
Tapa final con agujero
End cap with hole

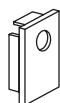

PF244 1,50€
Soporte perfil
Bracket profile

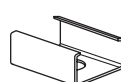

Pf250



Dimensiones en mm

Dimensions in mm

16,50€

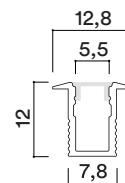

Accesorios - Accessories

PF251 4,80€
Difusor opal
Opal diffuser

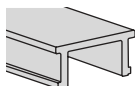

PF252 2,50€
Tapa final sin agujero
End cap without hole

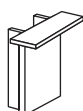

PF253 2,50€
Tapa final con agujero
End cap with hole

